



w w w . o p t i - s o l a r . c o m

SC-Max 48V series
Solar Charge Controller
30A

User Manual

Contents

1 Description of function	P 1
2 Safety Instructions and Waiver of Liability	P 1
2.1 Safety	P 1
2.2 Liability Exclusion	P 1
3 Dimensions	
4 Optional	P 1
4.1 Remote display unit	P 1
4.2 Remote temperature sensor	P 1
5 Installation	P 1
5.1 Mounting location requirements	P 2
5.2 Fastening the solar charge controller	P 2
5.3 Preparation of wiring	P 2
5.4 Connection	P 2
5.5 Grounding	P 2
6 Indication of Status	P 3
7 Operating the solar charge controller	
7.1 Factory Pre-Set configurations	P 4
7.2 Main Menu	
7.3 Menu Conf (System module settings)	P 5
7.4 Menu Prog (System parameter settings)	P 5
7.5 Menu Load (Load mode settings)	P 5
7.6 Menu Logg (Inquiry of internal data logger)	P 6
7.7 Example of configuration	P 6
7.7.1 Battery type	P 8
7.7.2 Reset to Factory Pre-Set Configuration	P 9
8 Safety Measures	P 10
8.1 Electronic Short Circuit Safety	P 10
8.2 Hardware Safety	P 10
8.3 Safety Features	
9 Malfunctions and Errors	P 11
10 Technical Data	P 11
10.1 Performance Data	P 11
10.2 Controlling Data(25°C)	
10.3 Parameter settings	P 12
	P 13
	P 13
	P 13
	P 13

Dear Clients,

Thanks for selecting the SC-MAX 48V series solar controller. Please take the time to read this user manual, this will help you to make full use of many advantages the controller can provide your solar system. This manual gives important recommendations for installing, program, using and so on. Read it carefully in your own interest please.

1. Description of function

With your new Max48 series controller you own a state-of-the-art device which was developed according to the latest available technical standards. It comes with a number of outstanding features, such as:

- LCD display
- One year's data memory
- 48V system voltage
- External temperature sensor, make the temperature compensation more accurate
- Perfect EMC design
- Many choices of battery type, working mode and protection
- Four stage PWM charge way: fast, boost, equalization, float
- Full automatic electronic protect function

3. Dimensions

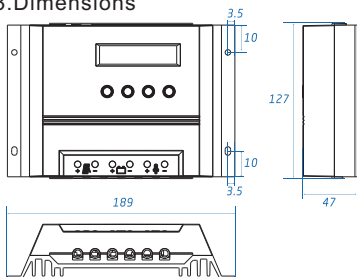

4. Optional

4.1 Remote display unit

Remote display unit can display system information, failure information and one year's charge and discharge data.

4.2 Remote temperature sensor

Acquisition the ambient temperature of the battery, which can be accurate compensation charge values, standard wire length is 2 meters (can also be customized according to user needs).

2. Safety instructions and waiver of liability

2.1 Safety

① The solar charge controller may only be used in PV systems in accordance with this user manual and the specifications of other modules manufacturers. No energy source other than a solar generator may be connected to the solar charge controller.

② Batteries store a large amount of energy, never short circuit a battery under all circumstances. We strongly recommend connecting a fuse directly to the battery to protect any short circuit at the battery wiring.

③ Batteries can produce flammable gases. Avoid making sparks, using fire or any naked flame. Make sure that the battery room is ventilated.

④ Avoid touching or short circuiting wires or terminals. Be aware that the voltages on special terminals or wires can be as much as twice the battery voltage. Use isolated tools, stand on dry ground, and keep your hands dry.

⑤ Keep children away from batteries and the charge controller.

2.2 Liability Exclusion

The manufacturer shall not be liable for damages, especially on the battery, caused by use other than as intended or as mentioned in this manual or if the recommendations of the battery manufacturer are neglected. The manufacturer shall not be liable if there has been service or repair carried out by any unauthorized person, unusual use, wrong installation, or bad system design.

5. Installation

5.1 Mounting location requirements

Do not mount the solar charge controller outdoors or in wet rooms. Do not subject the solar charge controller to direct sunshine or other sources of heat. Protect the solar charge controller from dirt and moisture. Mount upright on the wall on a non-flammable substrate. Maintain a minimum clearance of 10cm below and around the device to ensure unhindered air circulation. Mount the solar charge controller as close as possible to the batteries.

5.2 Fastening the solar charge controller

Mark the position of the solar charge controller fastening holes on the wall, drill 4 holes and insert dowels, fasten the solar charge controller to the wall with the cable openings facing downwards.

5.3 Preparation of wiring

Mode	Max.current	Diamete(mm ²)	AWG
SC-30Max	30A	16	6

5.4 Connection

We strongly recommend connecting a fuse directly to the battery to protect any short circuit at the battery wiring. Solar PV modules create current whenever light strikes them. The current created varies with the light intensity, but even in the case of low levels of light, full voltage is given by the modules. So, protect the solar modules from incident light during installation. Never touch uninsulated cable ends, use only insulated tools, and make sure that the wire diameter is in accordance with the solar charge controller's expected currents. Connections must always be made in the sequence described below (Figure 1: System wiring diagram).

1st step: Connect the battery

Connect the battery connection cable with the correct polarity to the middle pair of terminals on the solar charge controller (with the battery symbol). If the system is 48V, please make sure that the battery voltage is within 40V~64V. If the polarity is correct, the LCD screen on the controller will begin to show.

2nd step: Connect the solar module

Ensure that the solar module is protected from incident light. Ensure that the solar module does not exceed the maximum permissible input current. Connect the solar module connection cable to the correct pole of the left pair of terminals on the solar charge controller (with the solar module symbol).

3rd step: Connect loads

Connect the load cable to the correct pole of the right pair of terminals on the solar charge controller (with the lamp symbol). To avoid any voltage on the wires, first connect the wire to the load, then to the controller.

4th step: Final work

Fasten all cables with strain relief in the direct vicinity of the solar charge controller (clearance of approx.10cm).

5.5 Grounding

Be aware that the positive terminals of the controller are connected internally and therefore have the same electrical potential. If any grounding is required always do this on the positive wires.

Figure 1: System wiring

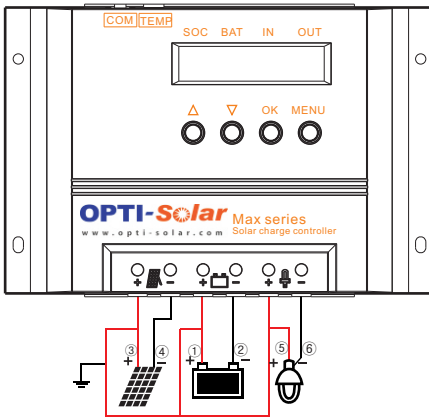

 Remark: If the device is used in a vehicle which has the battery negative on the chassis, loads connected to the controller must not have an electric connection to the car body, otherwise the low voltage disconnect and electronic fuse functions of the controller are short circuited.

6. Indication of Status

The two-line display indicates all present system values in short form on the top line, and the values are without units (Volt, Amp, etc) due to a lack of space. The printing above each value serves as a reminder:

State of charge SOC	Battery voltage BAT	Charging currents IN	Discharge currents OUT
------------------------	------------------------	-------------------------	---------------------------

"SOC" means "state of charge" and indicates how much remaining capacity the battery still has. The SOC is never 100% as due to technical reasons it is easier to indicate a two-digit number.

"BAT" shows the battery's actual voltage.

"IN" is the sum of the charging currents flowing into the battery.

"OUT" is the sum of discharge currents flowing out of the battery.

The second line constantly changes its information. All values and system information are indicated alpha-numerically. The following displays can only be seen during regular operation (not while programming).

SOC	BAT	IN	OUT
88%	50.8	26	18
I accu = 8.3A			

"I accu" is the balance of all charging and discharging currents. As long as the charging current is higher than the discharging current, the value is position, in the opposite case, it is negative.

88%	50.8	26	00
I in = 26.4A			

"I in" shows the charging current at the moment. When the voltage of the battery is getting near the final charge voltage, the solar charge controller will regulate the "I in" in order to protect the battery from being overcharged. The charge current "I in" is lower than the module current.

88%	50.8	00	15
Temp = 25°C			

"Temp" displays the environment temperature of the solar charge controller.

88%	50.8	17	15
Boost charging			

The solar charge controller status such as "Fast charging", "Equal charging", "Boost charging", "Float charging" and "No Charging" indicate which stage of charging is in process. After a certain period of time of operation in the "Boost" and "Equal" charging modes, the "Float" charge mode is resumed.

88%	50.8	00	15
Load on			

The content displays the current load state, "Load on" means the load has been opened, "Load off" means the load is in a closed state.

7. Operating the solar charge controller

7.1 Factory Pre-Set configurations

With the factory pre-set configurations, the solar charge controller can be used in most applications without further programming. On delivery, the controller is always set with these pre-set basic configurations that enable immediate use of most typical solar systems after installation.

The solar charge controller can be reset to the factory pre-set configurations at any time with the Menu CONF.

7.2 Main Menu

Set values and functions can be adjusted with the four control keys on the panel. By pressing the key under the MENU, a Main Menu appears in the display – Conf (System module settings), Prog (System parameter settings), Load (Load mode settings) and Logg (Inquiry of internal data logger). By pressing the key below the corresponding abbreviation, you can enter the corresponding menu (Figure 2: Programming Menu).

After entering the corresponding menu, the following actions can be set or viewed the appropriate information:

- ① You can use the keys ▲▼ to select sub-menu, and press the OK button to enter the sub-menu.
- ② After entering the sub-menu, press ▲▼ to change the value.
- ③ After setting, press the OK button to save the set value, and return to the previous menu level.
- ④ Pressing the MENU key will exit the setting, bring the display back to the normal Main Menu.



Note: 1.If you did not carry out any operation within 60s after entering the setup menu, the controller will automatically exit the menu programming and the normal indication of running status appears . 2.If there are no adjustments on an activated submenu value being changed, the display indication jumps to the main menu and the adjustment in the open window is not stored or applicable.

Figure 2: Programming Menu

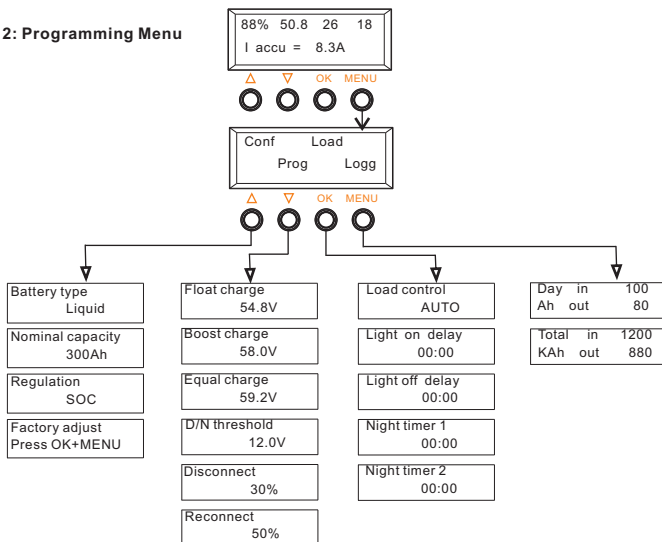

7.3 Menu Conf (System module settings)

In this menu, you can configure the system modules, including battery type, battery nominal capacity, low voltage protection mode and activate pre-set configurations. Press ▲ to enter the menu.

Battery type
Liquid

Battery type selection: Press the OK button to enter the menu, you may toggle between ▲▼ Gel to liquid electrolyte.

Possibilities for programming: Liquid, Gel (Default: Liquid).

Nominal capacity
300Ah

Battery nominal capacity: Press the OK button to enter the menu, press arrow keys ▲▼ for changing the nominal capacity and press OK for entering the new value.

Possibilities for programming: 10Ah~9990Ah (Default: 300Ah).

Note: The nominal capacity must be consistent with the actual battery capacity when the controller is installed.

Regulation
Soc

Low voltage protection mode (Soc or voltage control) settings: Press the OK button to enter the menu, and switch with the keys ▲ ▼ between SOC and Voltage.

Possibilities for programming: Soc, Voltage (Default: Soc).

Factory adjust
Press OK+MENU

Factory pre-set: Press the OK button to enter the menu, and press the "OK + MENU" button simultaneously to reset the solar charge controller.

Note: If you press "OK+MENU", all settings and values will be reset and the execution will be confirmed by "Done".

7.4 Menu Prog (System parameter settings)

In this menu you can set the charging parameters, Day/Night threshold, LVD and LVR data. Press ▼ to enter the menu.

Note: We have tried to insure that the values are limited within ranges that do not damage the battery immediately. However, certain skills are needed as far as battery behaviour is concerned to prevent long-term damage or poor system performance. If you are unsure about any of these settings, please refer to your authorised dealer or leave the pre-set configurations as they are.

Float charge
54.8V

Float voltage settings: Press the OK button to enter the menu, press ▲ ▼ to change the value.

Note: The float voltage serves for maintaining the charge in the battery for long periods and preventing self-discharge. This voltage should not be too high, since this may lead to permanent gassing, which damages the battery. Maximum values are stated on the battery data sheet of your battery. For most types of liquid battery, this float value is 54.8V.

Possibilities for programming: 51.7~58.0V (Default: 54.8V).

Boost charge
58.0V

Boost voltage settings: Press the OK button to enter the menu, press ▲ ▼ to change the value.

Possibilities for programming: 51.8~64.0V (Default: 58.0V).

Equal voltage settings: Press the OK button to enter the menu, press ▲ ▼ to change the value.

Equal charge
59.2V

Note: 1.The equalisation charging can only be adjusted for batteries with liquid electrolyte, since high equalising voltages are harmful for sealed batteries. The maximum equalising voltage value should be stated on the battery manufacturer's data sheet.
2.This window is deactivated if you have selected "Gel" with the menu CONF.
3.Battery charging voltage is passed on directly to the loads by the solar charge controller. Therefore, during equal charging, high charging voltages can be programmed that may damage some loads. Please select this equal charge voltage very carefully and compare the desired value to the battery and load (appliance) manufacturers' data sheets.
Possibilities for programming: 53.0~64.0V (Default: 59.2V).

Note: The fast charge voltage is fixed at 56.0V, users do not have their own set.

Day/Night threshold settings: Press the OK button to enter the menu, press ▲ ▼ to change the value.

D/N threshold
12.0V

The controller recognizes day and night based on the solar array open circuit voltage (only functional in street-light mode). This day/night threshold can be modified according to local light conditions and the solar array used.
Possibilities for programming: 12.0~30.0V(Default: 12.0V).

Low voltage disconnect settings: Press the OK button to enter the menu, press ▲ ▼ to change the value.

Disconnect
Soc = 30%

Note: 1.The difference between disconnect and reconnect threshold must be at least 20%. If you wish disconnect at higher state of charge you have to first adjust the reconnect threshold (as per below) to 20 % above the desired disconnect threshold.
2.When you configure voltage regulation, you will find in this window voltage values instead of SOC values for programming the disconnection voltage level.
The solar charge controller allows the smallest difference between reconnect and disconnect is 3.2V. If you want to program a high level for disconnection you must first increase the reconnection level.
Possibilities for programming by SOC: 20%~70% (Default: 30%).
Possibilities for programming by voltage regulation:
44.0~50.0V (Default: 44.4V).

Low voltage reconnected settings: Press the OK button to enter the menu, press ▲ ▼ to change the value.

Reconnect
Soc = 50%

Possibilities for programming by SOC: 40%~90% (Default: 50%).
Possibilities for programming: by voltage regulation: 47.2~53.2V (Default: 50.4V).

7.5 Menu Load (Load mode settings)

We can set load mode and time in this menu (Figure 3: Load mode), press the OK button to enter this menu.

Load control AUTO	Load mode settings: Press the OK button to enter the menu, and press ▲ ▼ to change the load mode. Possibilities for programming: "Auto", "Standard", "Timer" (Default: Auto).
----------------------	--

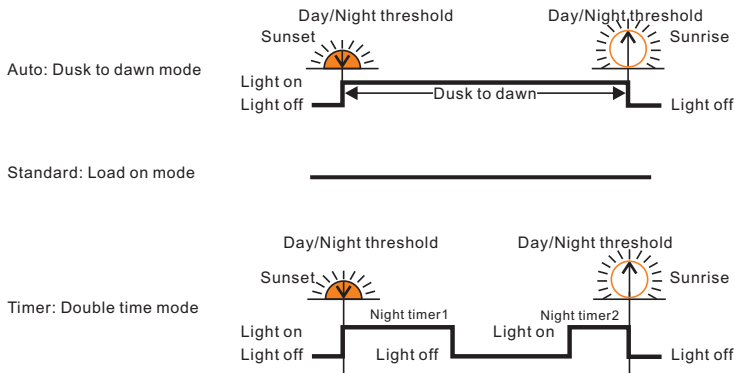

Figure3: Load mode

The time delay of load open settings: Press the OK button to enter the menu, press ▲ ▼ to change the value.

Light on delay 00:00

The solar charge controller can control night lighting automatically by evaluating the density of outside light with the help of the solar PV module array. Depending on the PV array alignment or shading, it may well be that night recognition is activated even though twilight has not yet come to an end. By the programmable time adjustment "Light on delay", the night light switch-on may be shifted to a later time.

Possibilities for programming: 00:00~02:00 (Interval 5min, Default: 00:00)

Light off delay 00:00

The delay time of load close settings: Press the OK button to enter the menu, press ▲ ▼ to change the value.

After setting "Light off delay" the light can remain on a period of time after dawn.
Possibilities for programming: 00:00~02:00 (Internal 5min, Default: 00:00).

Note: When the controller is set to "Standard", "Light on delay" and "Light off delay" have no effect on it, but when the controller is set to "Auto" and "Timer", the delay time settings work.

Night time 1 settings: Press the OK button to enter the menu, press ▲ ▼ to change the value.

Night timer 1
00:00

When the "Load control" is set to "Timer", "Night timer 1" is the first part light on time when dusk coming. If set to "Auto" or "Standard", "Night timer 1" setting is invalid.

Possibilities for programming: 00:00~09:00 (Interval 15min,Default: 00:00).

Night time 2 setting: Press the OK button to enter the menu, press ▲ ▼ to change the value.

Night timer 2
00:00

When the "Load control" is set to "Timer", "Night timer 2" is the second part light on time before dawn. If set to "Auto" or "Standard", "Night timer 2" setting is invalid.

Possibilities for programming: 00:00~09:00 (Interval 15min,Default: 00:00).

7.6 Menu Logg (Inquiry of internal data logger)

Press MENU button to enter the menu, you can recall stored data values from today to the last 7 days, at the same time you can view the accumulated value in and out of the system since the controller installed.

From this menu window, you can read the actual daily value of amp-hours in and out of the system. Press OK to toggle the display from today's current running data values to the stored data values for the last 7 days. You can choose the desired day to view with the arrow key ▲▼. The values can not be changed.

Day in	100
Ah out	80

Note: "Day" simply stands for today and "Day 1" for the day before, "Day 2" means two days ago. When a new day of logging starts, the data for each of "Day" to "Day 6" will be shifted to the previous day, i.e. the 7th day data will be replaced with the data for the 6th day, 6th day replaced by 5th day, etc.

Day 1 in	120
Ah out	90

Total in	1200
KAh out	880

View the accumulated value in and out of the system since the controller installed, this data can not be changed.

Note: The minimum value is 1KAh.

Note: All historical data will be deleted only when the device been reset to factory settings.

7.7 Example of configuration

7.7.1 Battery type

By pressing the MENU key, you leave the online status display and go to the main menu. By pressing the key below the corresponding abbreviation: Conf (System module settings), Prog (System parameter settings), Load (Load mode settings) and Logg (Inquiry of internal data logger), you can enter the corresponding menu. In the case of this example you have to press the first key from left (labelled▲), which is below the abbreviation Conf. This is how you get into the window for programming the Battery type (Figure 4: Change the battery type).

Note: If you have pressed the wrong key by accident, press MENU to get back to the main menu and start all over again.

7.7.2 Reset to Factory Pre-Set Configuration

In the previous section, it is described how to enter the window Battery type. The next window up (press ▲) is for resetting the solar charge controller to the factory pre-set configuration (Factory adjust). By pressing OK you can enter the Factory adjust window. The instruction to press the MENU key plus the OK key appears immediately. Only by pressing both of these keys simultaneously will the factory pre-set configurations be set. Then the second line shows "Done", means successfully restore the factory settings (Figure 5: Reset to Factory Pre-Set configuration).

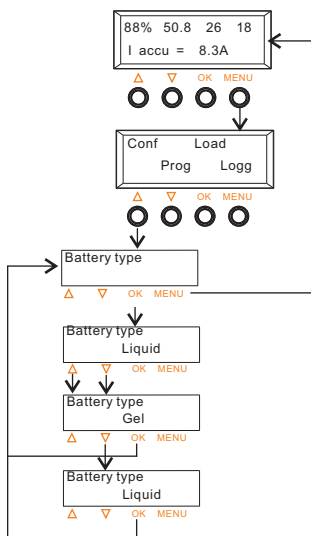

Figure 4: Change the battery type

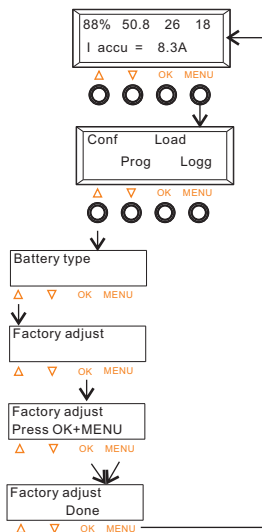

Figure 5: Reset to Factory Pre-Set configuration

- Note: 1. If you want to make sure that you have programmed correctly, press only OK and move through all submenu items to check the values. Do not press the arrow keys while checking, or you will change the values.
2. If you have programmed a wrong value, you will reach the window with the undesired value again and press OK to change the value to the correct one by pressing the arrow keys▲▼.

8 Safety Measures

We urgently recommend the installation of a safety device on the battery pole in order to prevent damage from short circuits between battery and the solar charge controller.

8.1 Electronic Short Circuit Safety

An electronic short circuit safety device is built into the solar charge controller and prevents both destruction of the solar charge controller and the blowing of the safety fuse in case of short circuits on the load terminals. The second line of the LCD display indicates this error as "Short circuit". After elimination of this fault, the solar charge controller automatically switches back to normal operation after about 60 seconds.

8.2 Hardware Safety

In addition to the electronic fuse device mentioned above, the solar charge controller has also been protected by regular fuses which have been rated far beyond nominal currents to prevent false blowing of the fuses during surges. The safety fuses are wired in parallel. In order to prevent fuses from blowing in the case of high currents over a short period of time, a high value has been selected. Before the fuses blow, the electronic safety fuse should prevent any excessive current flow.

8.3 Safety Features

	Solar terminal	Battery terminal	Load terminal
Reverse polarity	Protected *1	Protected *1	Protected *2
Short circuit	Protected	Protected *3	Switches off immediately
Over current	—	—	Switches off with delay
Reverse Current	Protected	—	—
Over voltage	Max. 110V *4	Max. 80V	—
Low voltage	—	—	Switches off
Over temp	—	—	—
	switches off the load if the temperature reaches the set value		

*1 Controller can not protect itself in a 48V system when polarity of battery or solar is reversed.

*2 Controller can protect itself, but loads might be damaged.

*3 Battery must be protected by fuse, or battery will be permanently damaged.

*4 The solar panel voltage should not exceed this limit for a long time as voltage protection is done by a varistor.

Warning: The combination of different error conditions may cause damage to the controller. Always remove the error before you continue connecting the controller.

9 Malfunctions and Errors

The solar charge controller is protected against damage by various measures. Nevertheless, always take utmost care in the proper operation of the solar charge controller. Short hints of the malfunctions are indicated with the help of the LCD display. However, errors are only properly indicated in which the system has been properly installed. If there are other malfunctions than the ones described below, please check first of all if the solar charge controller has been connected to the battery, the module and the loads correctly in the right polarity. Afterwards, check the safety fuses.

Error message	The cause of the malfunction	Remedy
Short circuit	Short circuit	Switch off all loads. Remove the fault, the controller will switch on load automatically after 1 minute.
Over current	The load current is too high and the output is disconnected. Either the whole consumption exceeds the max. discharge currents or the max. Pulse currents were exceeded by using high surge appliances.	
Low voltage	Battery has low capacity. To protect the battery, all loads powered by the solar charge controller will be disconnected.	<ul style="list-style-type: none"> • Reduce loads or hours of operation of loads to keep the battery from being discharged deeply, or increase solar array to add energy to the system. • Connect all loads through the controller to avoid strong discharge of the battery. • It will restore only when the battery being recharged and the voltage reaching the reconnect voltage.
Over heat	The maximum allowable temperature has been exceeded. In order to reduce further heat generation the loads are disconnected automatically. As soon as the solar charge controller has cooled down, normal operation will resume.	<ul style="list-style-type: none"> • Check the ventilation at the back heat sink and clean it if necessary. • Protect the controller from direct sunshine. • Reduce warming caused by appliances near the controller. • Reduce the loads or PV modules.
Over voltage	In particular, the recharge process through back-up generators or chargers tied directly to the battery causes battery voltages higher than 66.0V.	Disconnect external chargers, when the battery voltage is lower than 62.0V controller automatically restored.
LCD has no display	<ul style="list-style-type: none"> • There is no voltage feed from the battery. • current operating temperature is too high or too low above/below the operating temperature, causing LCD not to function. 	<ul style="list-style-type: none"> • Check the battery connections and fuses. • Check the working temperature. • Reinstall the controller, disconnect everything and connect it again in the right order.

10. Technical Data

	Max 1048 (Max 10HV)	Max 2048 (Max 20HV)	Max 3048 (Max 30HV)
System voltage	48 V Fixed		
Max solar current or load current	10 A	20 A	30 A
Float voltage	51.7~58.0V, Default: 54.8V (25°C)		
Fast voltage	56.0V (25°C)		
Boost voltage	51.8~64.0V, Default: 58.0V (25°C)		
Equal voltage	53.0~64.0V, Default: 59.2V (25°C)		
Day/Night threshold	12.0~30.0V, Default: 12V		
Load disconnect voltage	Soc	20~70%, Default: 30%	
	Voltage	44.0~50.0V, Default: 44.4V	
Load reconnect voltage	Soc	40~90%, Default: 50%	
	Voltage	47.2~53.2V, Default: 50.4V	
Battery type	Liquid, Gel		
Nominal capacity	10Ah~9990Ah, Default: 300Ah		
Low voltage protection mode	Soc, Voltage		
Load mode	Auto, Standard, Timer		
Light on delay	00:00 - 02:00 (Internal 5min)		
Light off delay	00:00 - 02:00 (Internal 5min)		
Night time 1	00:00 - 09:00 (Internal 15min)		
Night time 2	00:00 - 09:00 (Internal 15min)		
Temperature compensation	-4.17 mV/K per cell (Boost and Equal charge), -3.33 mV/K per cell (Float charge)		
Max solar voltage	110 V		
Max battery voltage	80 V		
Dimensions/Weight	127*189*47mm / 550g		
Max wire size	25mm ²		
Max power consumption	7mA		
Temp. Range during operation	-10°C ~ +60 °C		
Storage temperature	-25°C ~ +80 °C		
Relative humidity	10%~90% Non-condensation		
Case protection	IP32		